

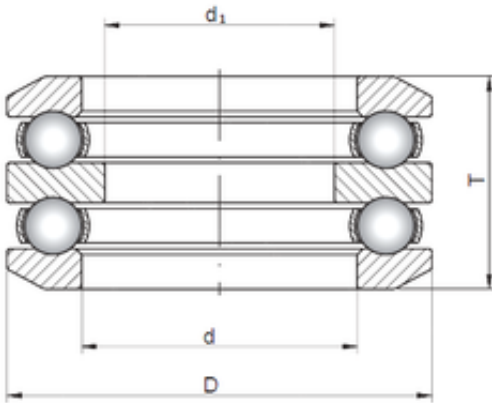

ISO 54202 thrust ball bearings



Bearing No. 54202

Size	17x32x24.6 mm
Bore Diameter	17 mm
Outer Diameter	32 mm
Width	24,6 mm
d	17 mm
d1	10 mm
D	32 mm
T	24,6 mm

54202 Bearing 2D drawings and 3D CAD models